

# JVC

# SCHEMATIC DIAGRAMS

## COLOR TELEVISION

### AV-24F702

CD-ROM No.SML200101



# AV-24F702 STANDARD CIRCUIT DIAGRAM

## ■ NOTE ON USING CIRCUIT DIAGRAMS

### 1.SAFETY

The Components identified by the symbol  $\triangle$  are critical for safety. For continued safety, replace safety critical components only with manufacturer's recommended parts.

### 2.INDICATION OF PARTS SYMBOL [EXAMPLE]

●In the PC board :R1209→R209

### 3.NOTE FOR REPAIRING SERVICE

This model's power circuit is partly different in the GND.

Please, care must be taken for the following points.

(1)Do not touch the LIVE side GND or the LIVE side GND and the ISOLATED(NEUTRAL) side GND simultaneously. If the above caution is not respected, an electric shock may be caused. Therefore, make sure that the power cord is surely removed from the receptacle when, for example, the chassis is pulled out.

(2)Do not short between the LIVE side GND and ISOLATED(NEUTRAL) side GND or never measure with a measuring apparatus ( oscilloscope, etc.) the LIVE side GND and ISOLATED(NEUTRAL) side GND at the same time. If the above precaution is not respected , a fuse or any parts will be broken.

◇ Since the circuit diagram is a standard one, the circuit and circuit constants may be subject to change for improvement without any notice.

## CONTENTS

<b>SEMICONDUCTOR BASE CONNECTIONS</b> .....	<b>2</b>
<b>BLOCK DIAGRAMS</b> .....	<b>3</b>
<b>CIRCUIT DIAGRAMS</b> .....	<b>5</b>
<i>MAIN PCB MICON/TUNER SCHEMATIC DIAGRAM</i>	
<i>MAIN PCB CHROMA/IF SCHEMATIC DIAGRAM</i>	
<i>MAIN PCB DEFLECTION SCHEMATIC DIAGRAM</i>	
<i>MAIN PCB POWER SCHEMATIC DIAGRAM</i>	
<i>MAIN PCB SOUND SCHEMATIC DIAGRAM</i>	
<i>MAIN PCB AV SCHEMATIC DIAGRAM</i>	
<i>COMB FILTER PCB SCHEMATIC DIAGR</i>	
<i>CRT/SVM PCB SCHEMATIC DIAGRAM</i>	
<b>PATTERN DIAGRAMS</b> .....	<b>21</b>
<i>MAIN/ PCB PATTERN</i>	
<i>COMB FILTER PCB PATTERN</i>	
<i>CRT/SVM PCB PATTERN</i>	
<b>WAVEFORMS</b> .....	<b>27</b>

# SEMICONDUCTOR BASE CONNECTIONS

## DIODE

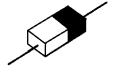

1SS133T-77  
AU02A-EIC  
HZ30-3L TD  
MTZJ11B T-77  
MTZJ12B T-77  
MTZJ27B T-77  
MTZJ5.1B T-77  
MTZJ5.6B T-77  
MTZJ6.2B T-77  
MTZJ9.1B T-77  
RS-4FS

10ELS6N-TA1B2  
11E1-EIC  
30DF6-FC  
RU2YX-V1

10ELS2N-TA1B2  
21DQ09N-FC4  
21DQ09N-TA2B1  
RM11C-EIC  
RU-4AM

1SS355 TE-17

## IC

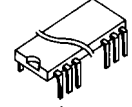
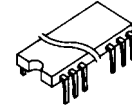

SLR-342VCT32

OEC7055A  
TB1253N

M62420SP  
MM1311AD

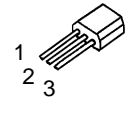
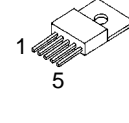
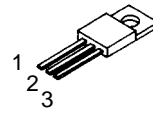
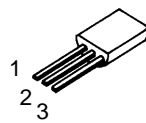
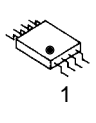
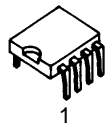
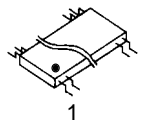

AN5829S

S-24C08ADPA-01

NJM2150AM

PST600C

KIA7805API  
KIA7809API

STR-G6624

KIA78L05BP-AT  
KIA78L12BP-AT

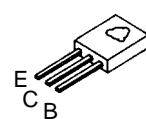
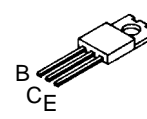
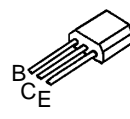
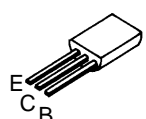
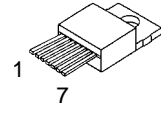
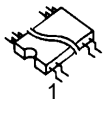
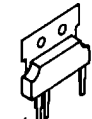

AN5276

TC90A53F

LA78041

2SA1015Y(TPE2)  
2SB926(S,T)-AA  
2SC1815Y(TPE2)  
2SC752(G)(TM)\_Y  
2SD734(E,F)-AA

2SC1740SP TP

2SC4159(D,E)

2SC2621(D,E)-RAC

## TRANSISTOR

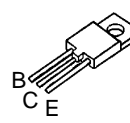
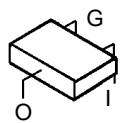
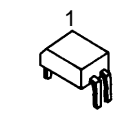
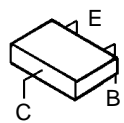
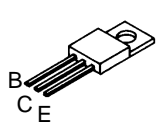

2SA1837  
2SC4793

2SA1037AKT146R,S  
2SC2412KT146 R,S  
2SC2814(F3,F4)-T

TLP621(D4-GR-LF2)

DTA144EKAT146  
DTC114EKAT146  
DTC114TKAT146

2SD2553

# BLOCK DIAGRAMS

- ◀ R.SIGNAL
- △ G.SIGNAL
- ▽ B.SIGNAL
- ↕ DEFLECTION SIGNAL
- ↕ AUDIO SIGNAL(REC)
- ↕ TUNER VIDEO SIGNAL
- ↕ RECORD LUMINANCE SIGNAL
- ↕ RECORD COLOR SIGNAL

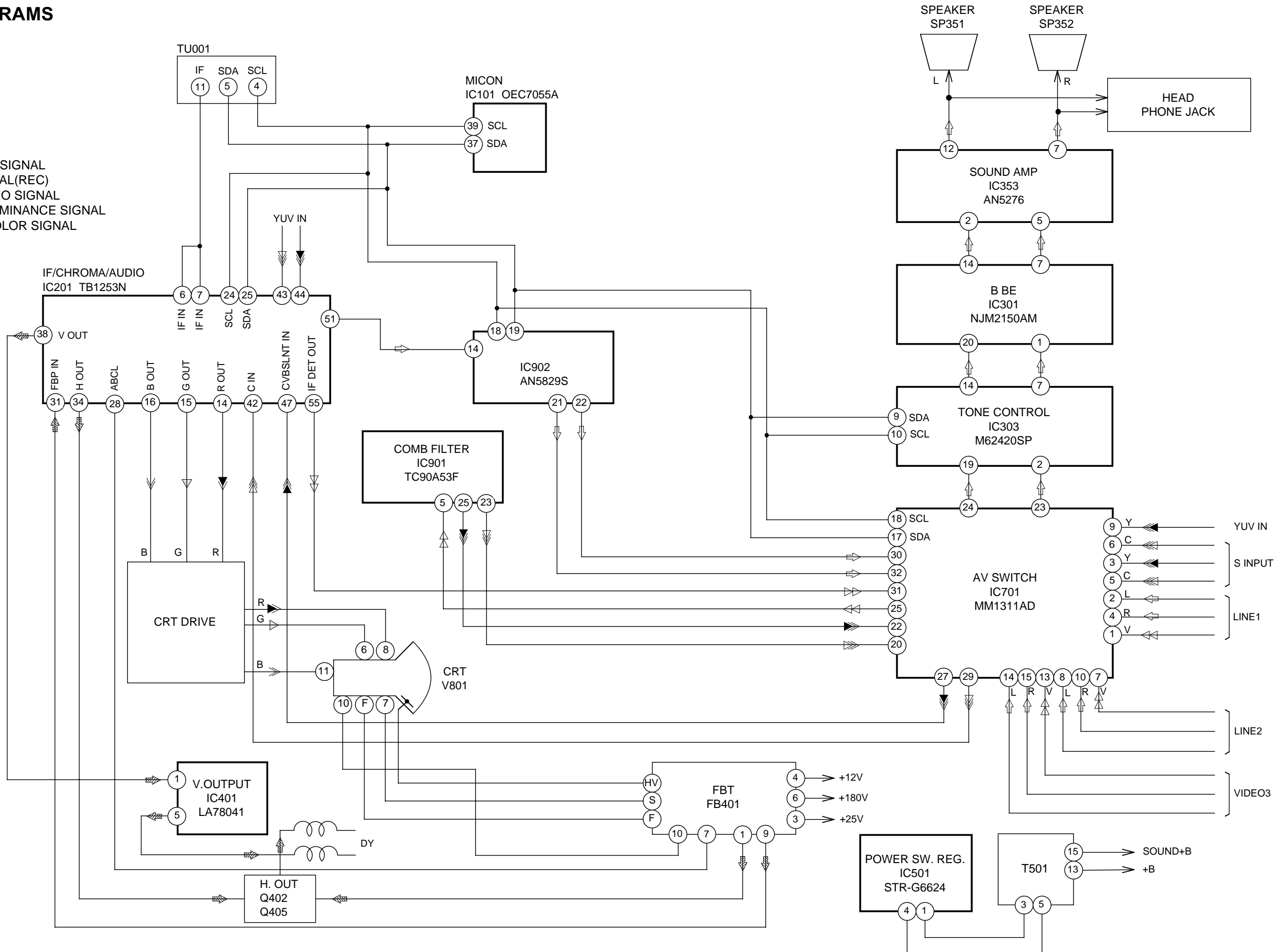

# CIRCUIT DIAGRAM

## [ MAIN PCB MICON/TUNER SCHEMATIC DIAGRAM ]

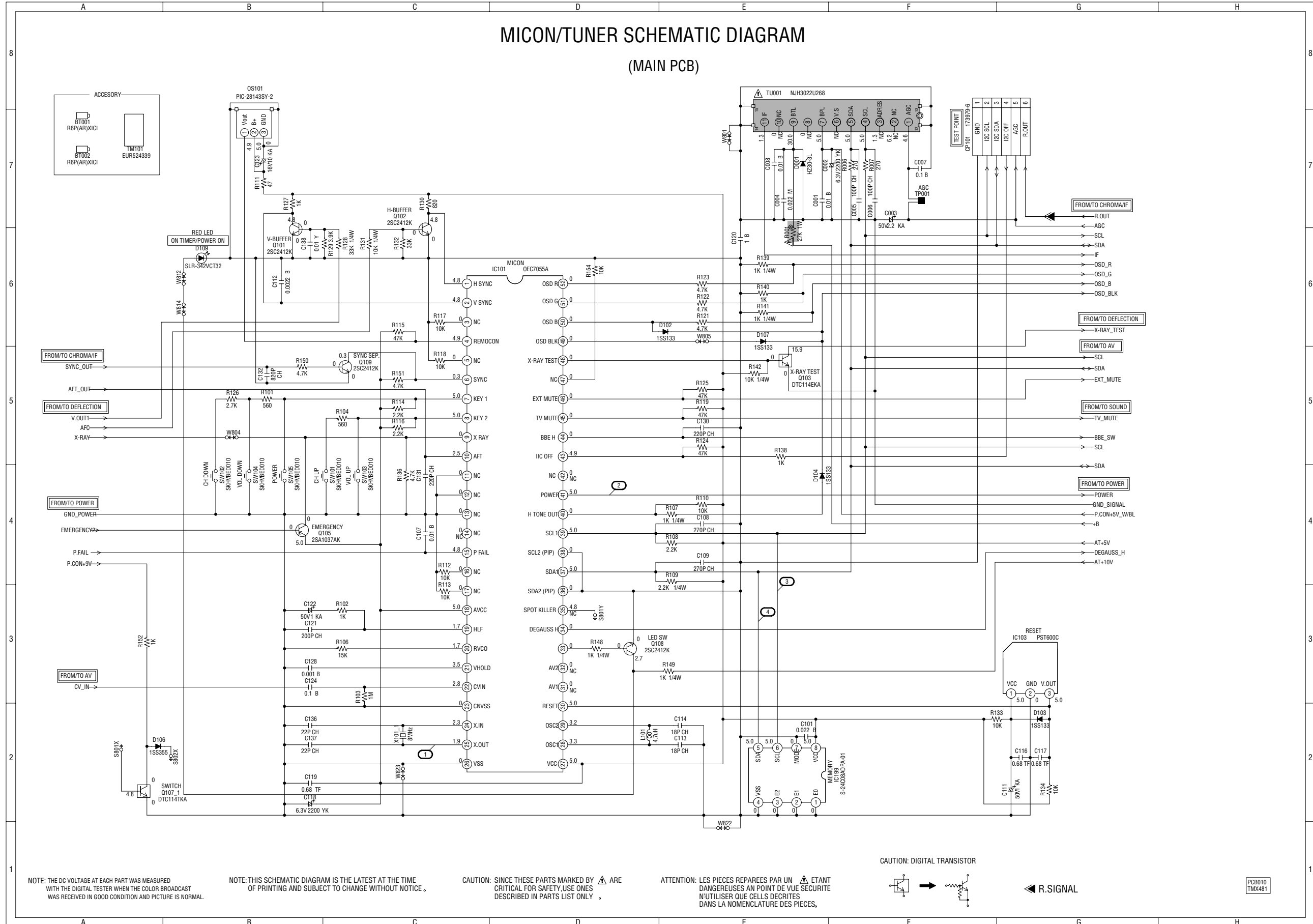

[ MAIN PCB CHOROMA/IF SCHEMATIC DIAGRAM ]

CHROMA/IF SCHEMATIC DIAGRAM (MAIN PCB)

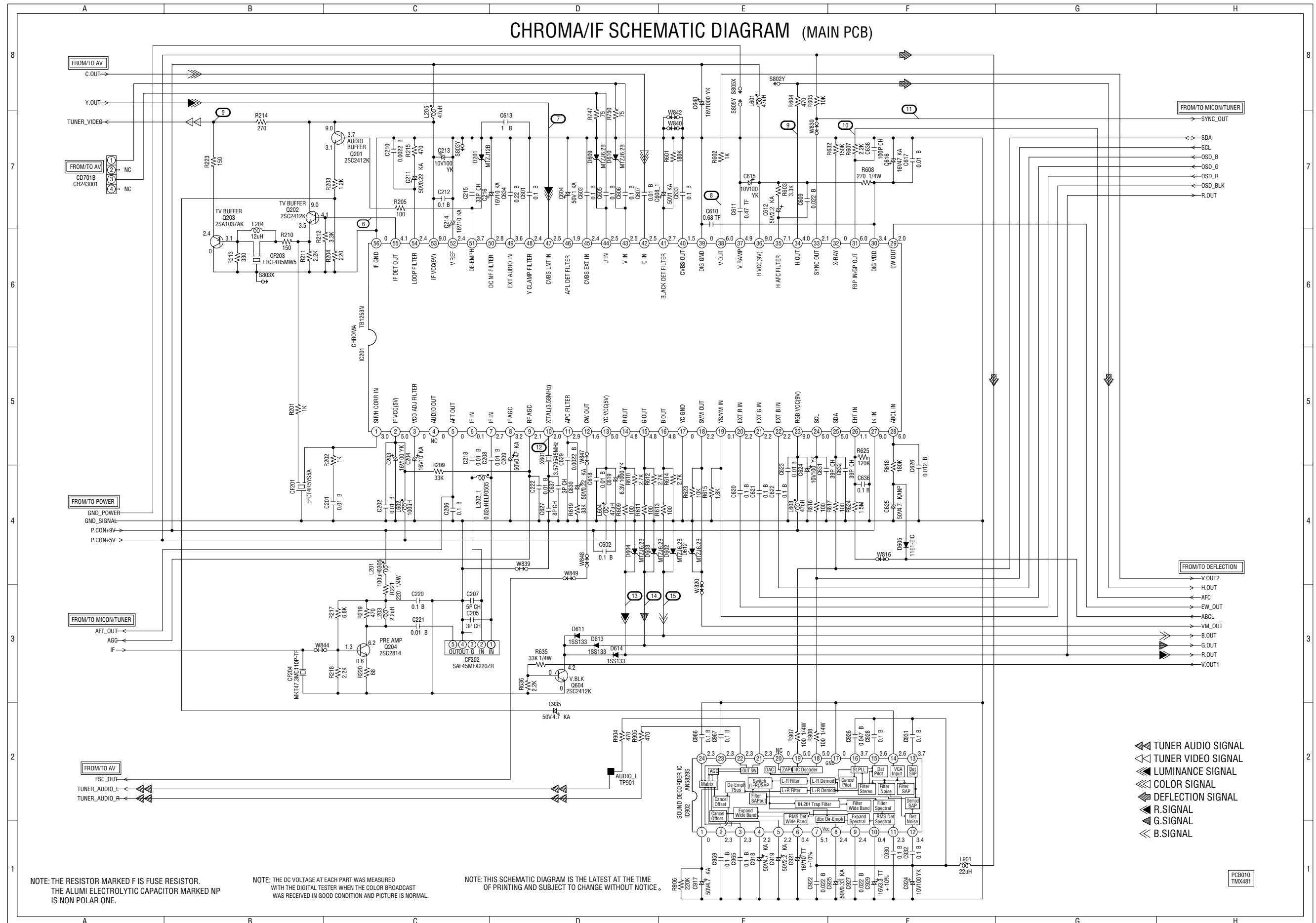

[ MAIN PCB DEF DIAGRAM ]

DEFLECTION SCHEMATIC DIAGRAM (MAIN PCB)

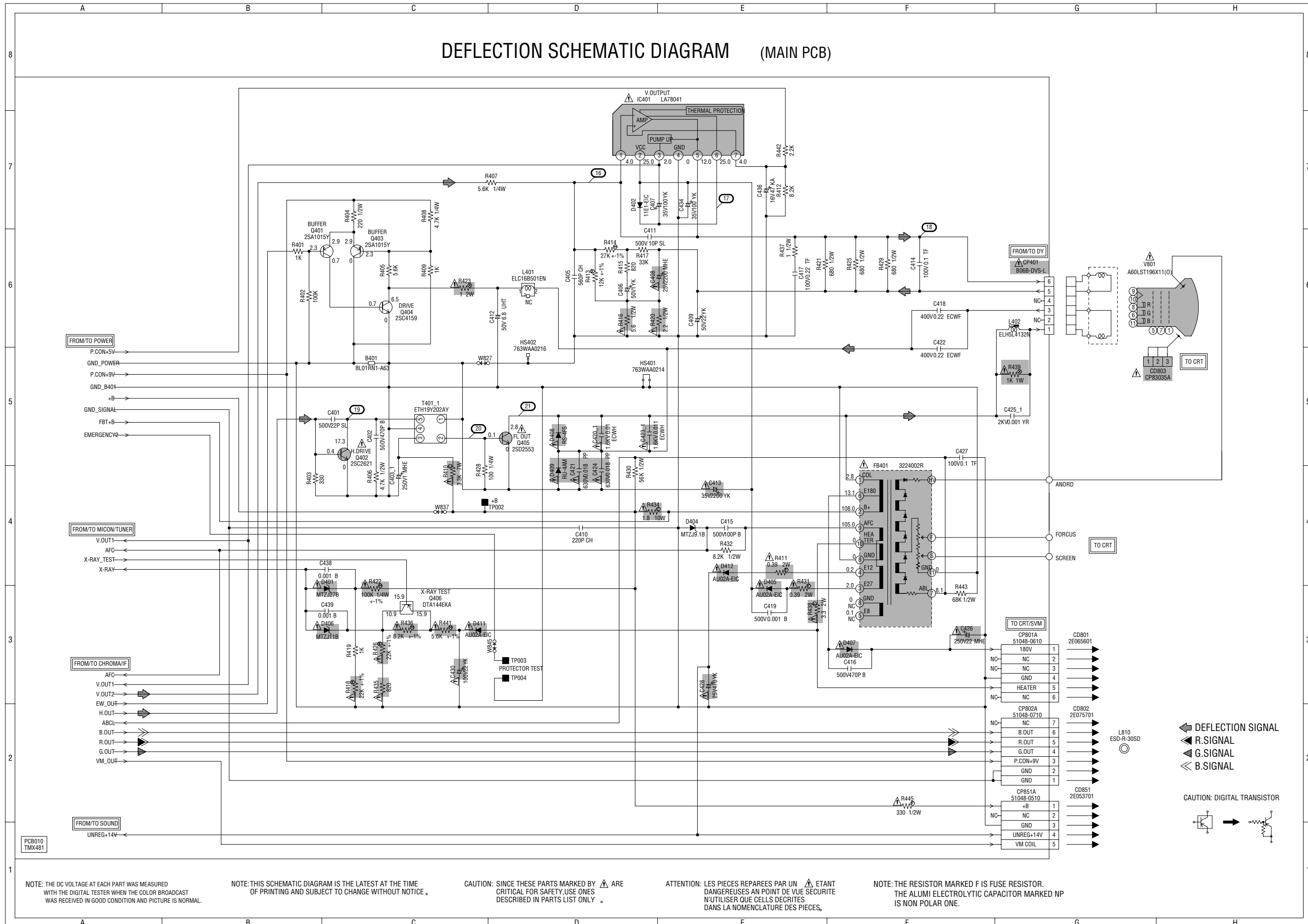

NOTE: THE DC VOLTAGE AT EACH PART WAS MEASURED WITH THE DIGITAL TESTER WHEN THE COLOR BROADCAST WAS RECEIVED IN GOOD CONDITION AND PICTURE IS NORMAL.

NOTE: THIS SCHEMATIC DIAGRAM IS THE LATEST AT THE TIME OF PRINTING AND SUBJECT TO CHANGE WITHOUT NOTICE.

CAUTION: SINCE THESE PARTS MARKED WITH A TRIANGLE ARE CRITICAL FOR SAFETY, USE ONES DESCRIBED IN PARTS LIST ONLY.

ATTENTION: LES PIÈCES RÉPARÉES PAR UN TRIANGLE ÉTANT DANGEREUSES AN POINT DE VUE SÉCURITÉ N'UTILISER QUE CELLES DÉCRITES DANS LA NOMENCLATURE DES PIÈCES.

NOTE: THE RESISTOR MARKED WITH F IS FUSE RESISTOR. THE ALUMI ELECTROLYTIC CAPACITOR MARKED NP IS NON POLAR ONE.

[ MAIN PCB POWER CIRCUIT DIAGRAM ]

POWER SCHEMATIC DIAGRAM

(MAIN PCB)

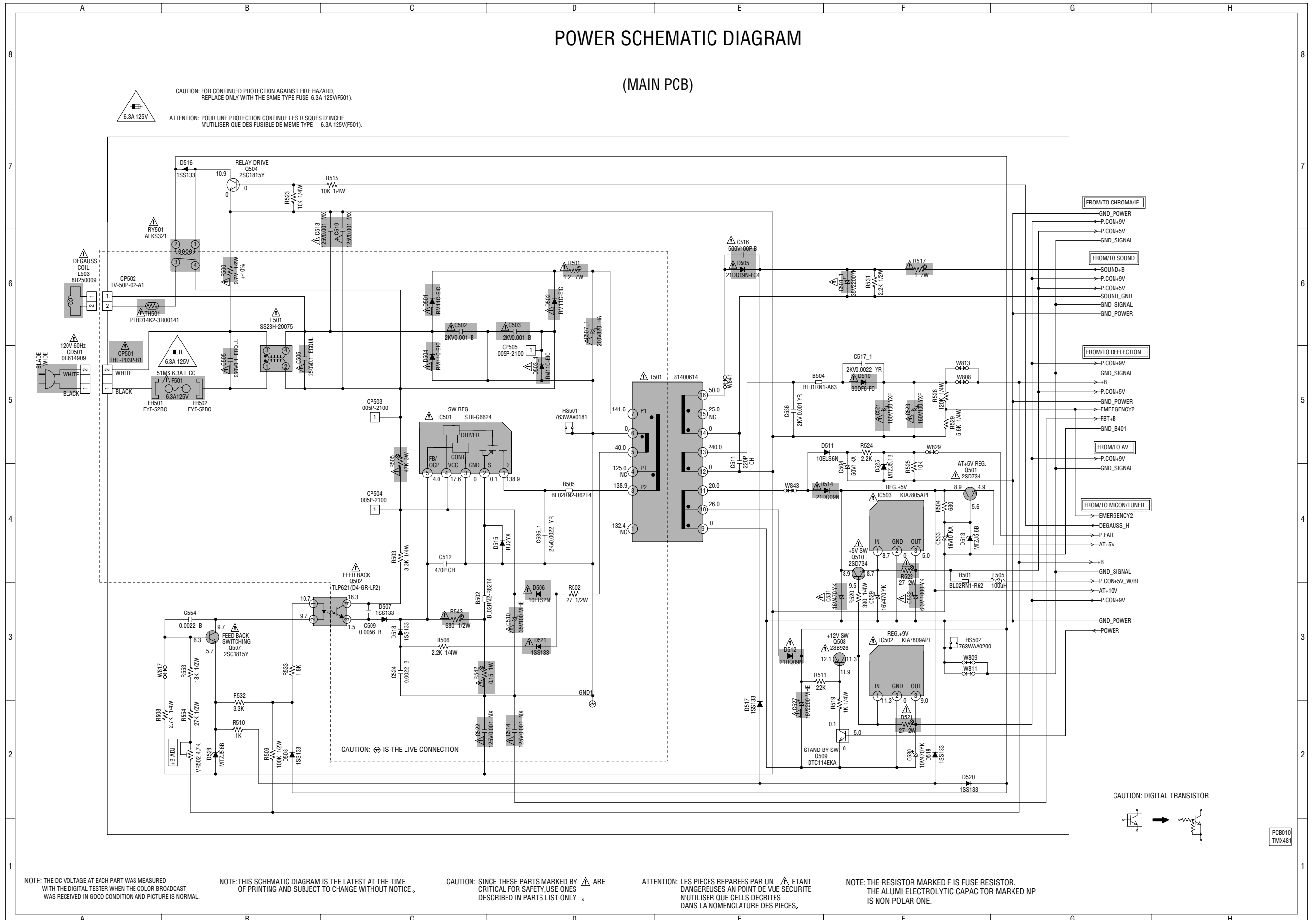



[ MAIN PCB SOUND CIRCUIT DIAGRAM ]

SOUND SCHEMATIC DIAGRAM (MAIN PCB)

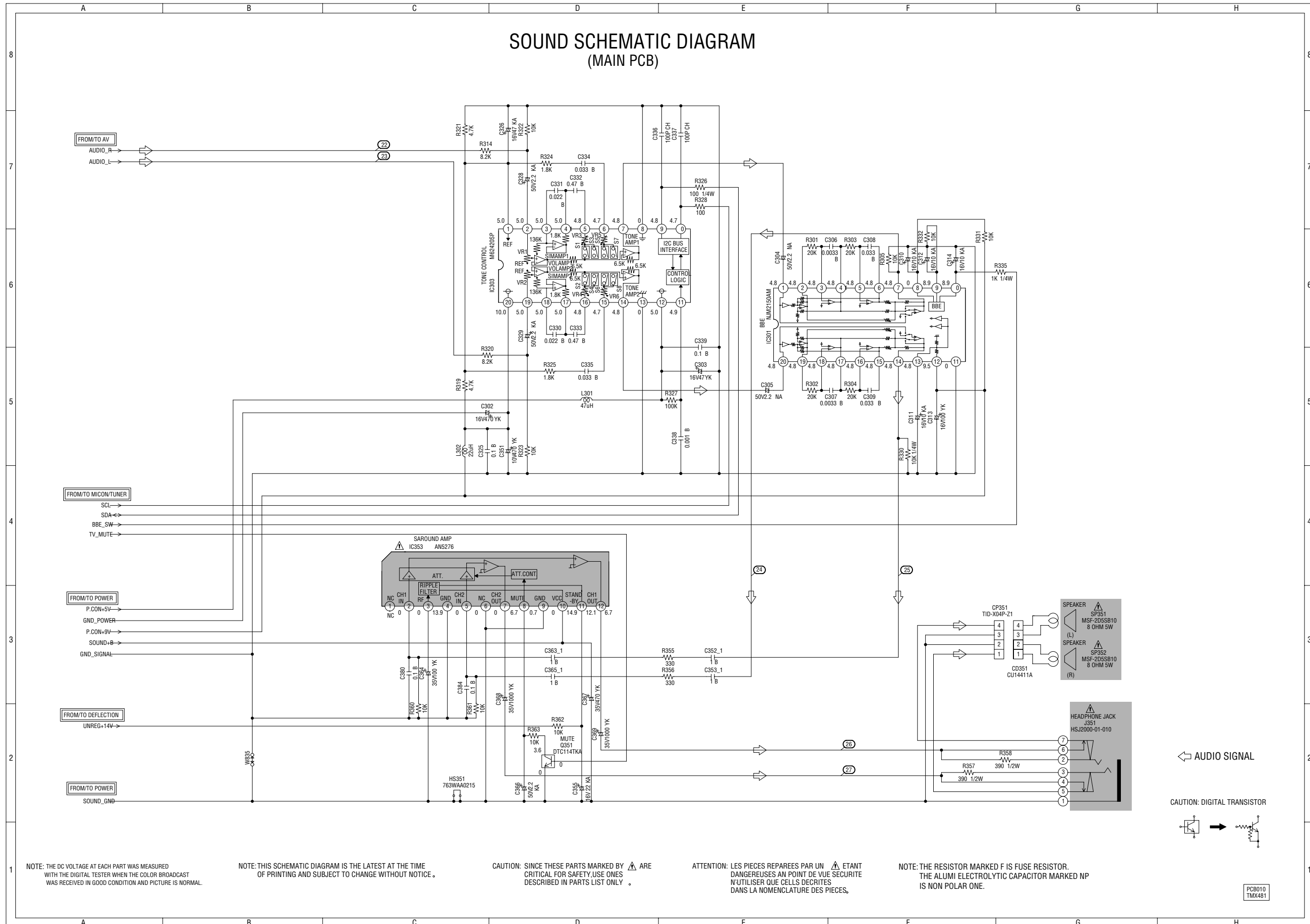

NOTE: THE DC VOLTAGE AT EACH PART WAS MEASURED WITH THE DIGITAL TESTER WHEN THE COLOR BROADCAST WAS RECEIVED IN GOOD CONDITION AND PICTURE IS NORMAL.

NOTE: THIS SCHEMATIC DIAGRAM IS THE LATEST AT THE TIME OF PRINTING AND SUBJECT TO CHANGE WITHOUT NOTICE.

CAUTION: SINCE THESE PARTS MARKED BY  $\Delta$  ARE CRITICAL FOR SAFETY, USE ONES DESCRIBED IN PARTS LIST ONLY.

ATTENTION: LES PIÈCES REPARÉES PAR UN  $\Delta$  ÉTANT DANGEREUSES AN POINT DE VUE SÉCURITÉ N'UTILISER QUE CELLES DÉCRITES DANS LA NOMENCLATURE DES PIÈCES.

NOTE: THE RESISTOR MARKED F IS FUSE RESISTOR. THE ALUMI ELECTROLYTIC CAPACITOR MARKED NP IS NON POLAR ONE.

← AUDIO SIGNAL

CAUTION: DIGITAL TRANSISTOR

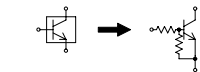

PCB010  
TMX481

[ MAIN PCB AV CIRCUIT DIAGRAM ]

AV SCHEMATIC DIAGRAM

(MAIN PCB)

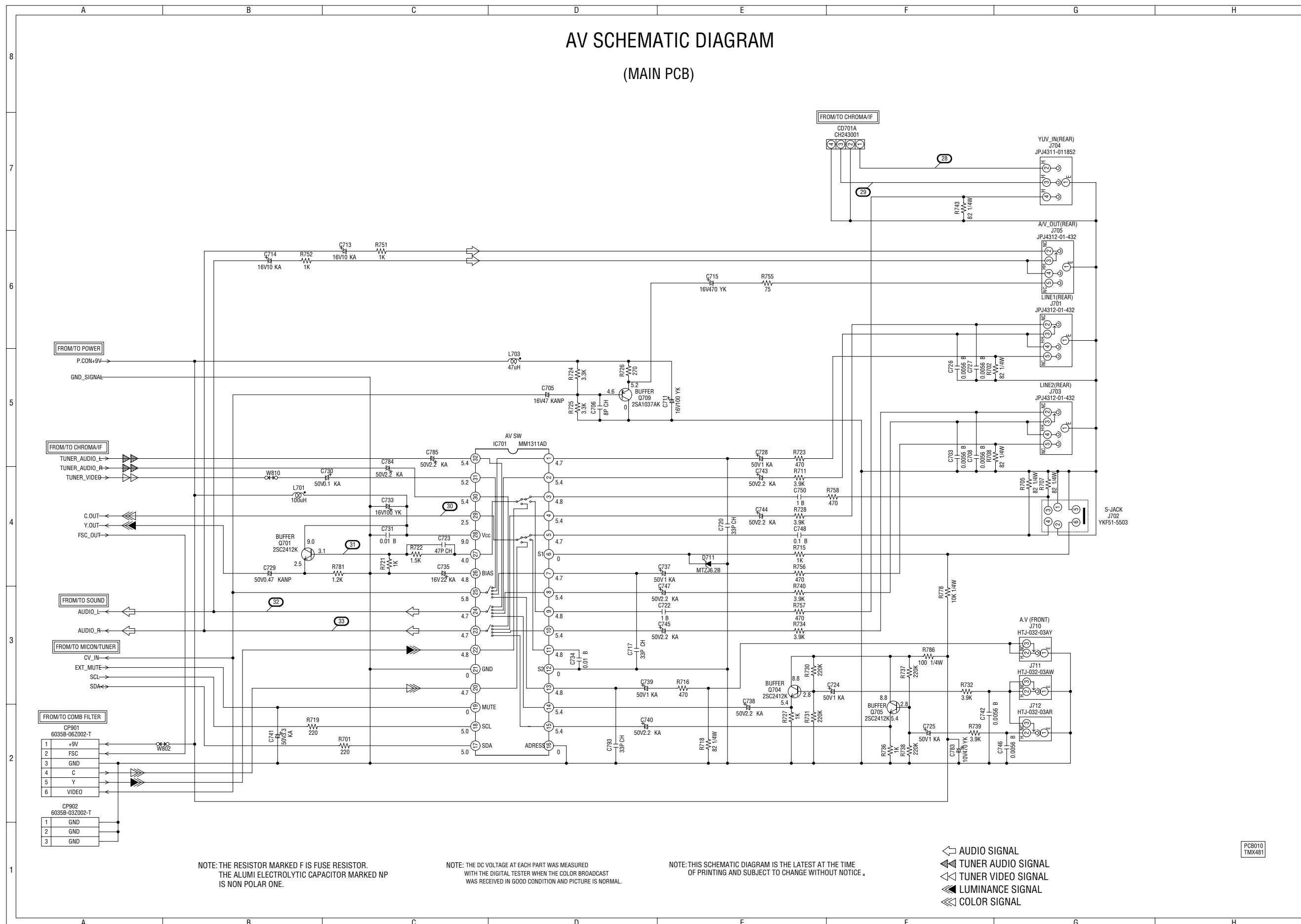

NOTE: THE RESISTOR MARKED F IS FUSE RESISTOR. THE ALUMI ELECTROLYTIC CAPACITOR MARKED NP IS NON POLAR ONE.

NOTE: THE DC VOLTAGE AT EACH PART WAS MEASURED WITH THE DIGITAL TESTER WHEN THE COLOR BROADCAST WAS RECEIVED IN GOOD CONDITION AND PICTURE IS NORMAL.

NOTE: THIS SCHEMATIC DIAGRAM IS THE LATEST AT THE TIME OF PRINTING AND SUBJECT TO CHANGE WITHOUT NOTICE.

- ◁ AUDIO SIGNAL
- ▷ TUNER AUDIO SIGNAL
- ▷ TUNER VIDEO SIGNAL
- ▷ LUMINANCE SIGNAL
- ▷ COLOR SIGNAL

PCB010 TMX481

[ COMB FILTER PCB CIRCUIT DIAGRAM ]

COMB FILTER SCHEMATIC DIAGRAM  
(COMB PCB)

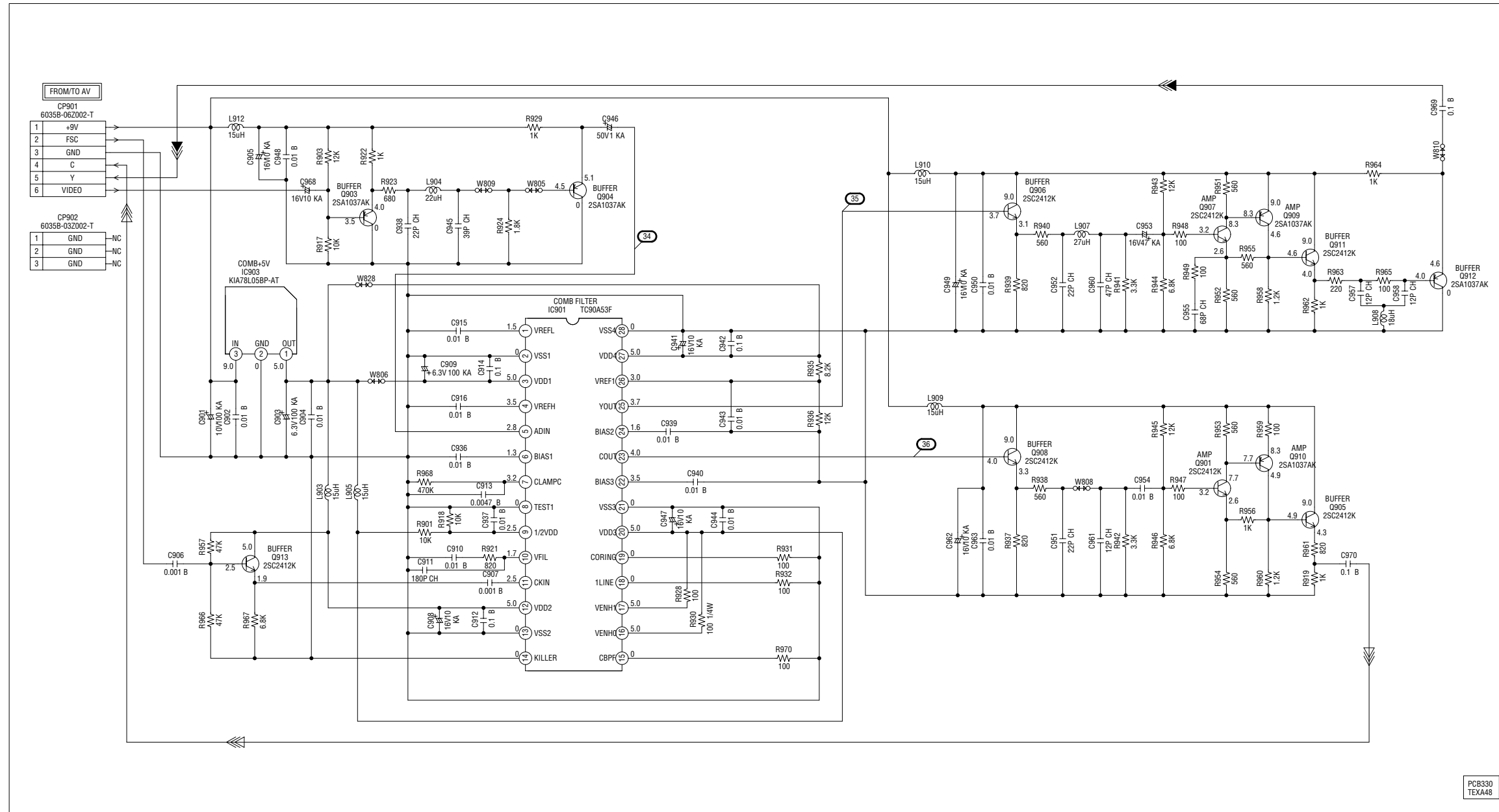

PCB330  
TEXA48

NOTE: THE DC VOLTAGE AT EACH PART WAS MEASURED WITH THE DIGITAL TESTER WHEN THE COLOR BROADCAST WAS RECEIVED IN GOOD CONDITION AND PICTURE IS NORMAL.

NOTE: THIS SCHEMATIC DIAGRAM IS THE LATEST AT THE TIME OF PRINTING AND SUBJECT TO CHANGE WITHOUT NOTICE.

◀ LUMINANCE SIGNAL  
◀ COLOR SIGNAL

[ CRT/SVM PCB CIRCUIT DIAGRAM ]

CRT/SVM SCHEMATIC DIAGRAM

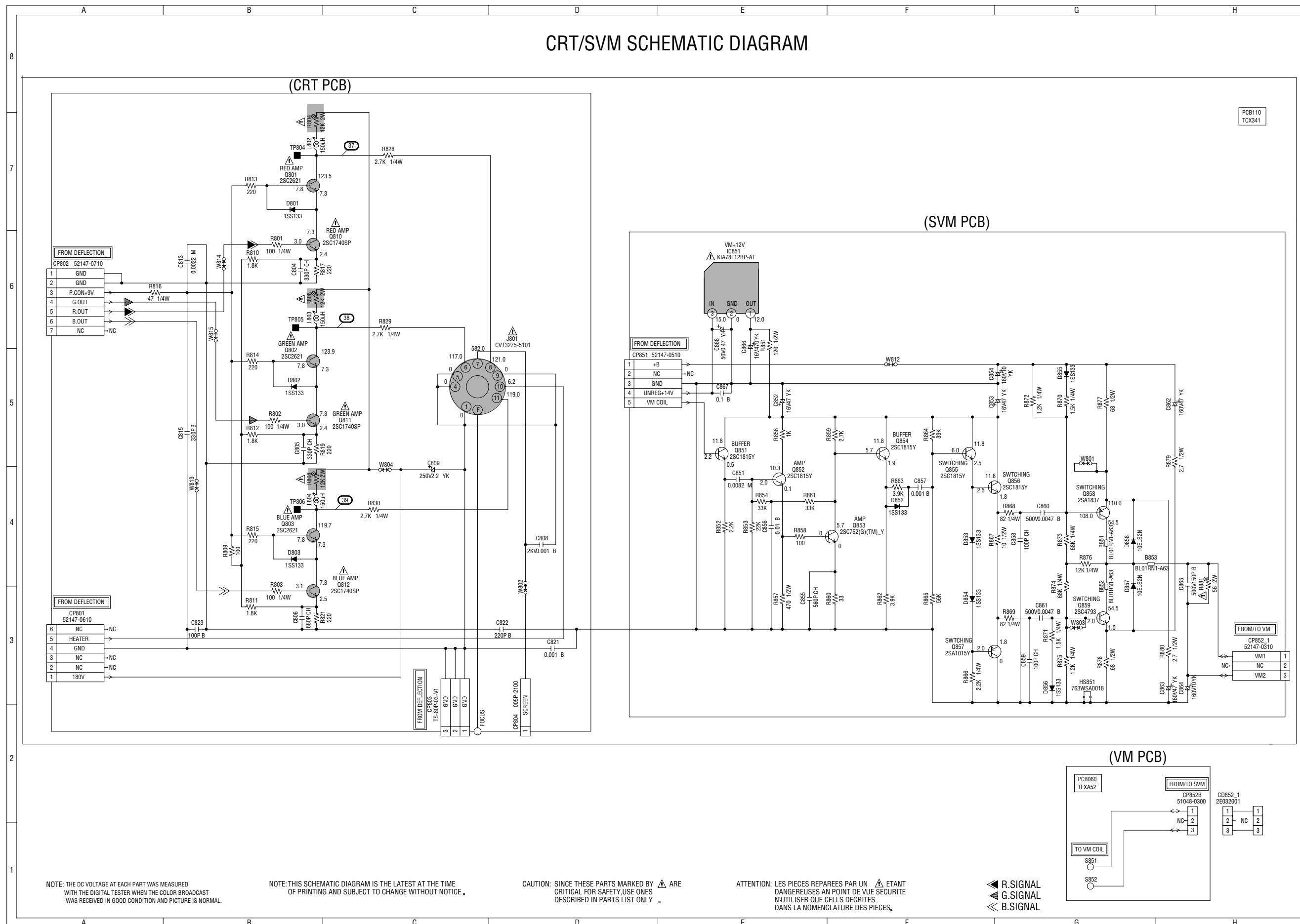





[ COMB FILTER PCB PATTERN (INSERTED PARTS) ]

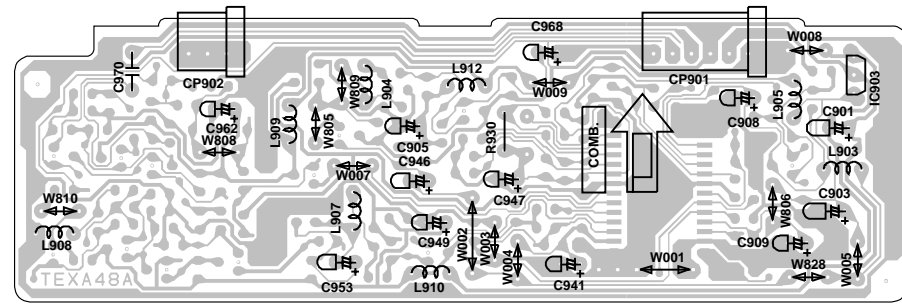

[ CRT/SVM PCB PATTERN (INSERTED PARTS) ]

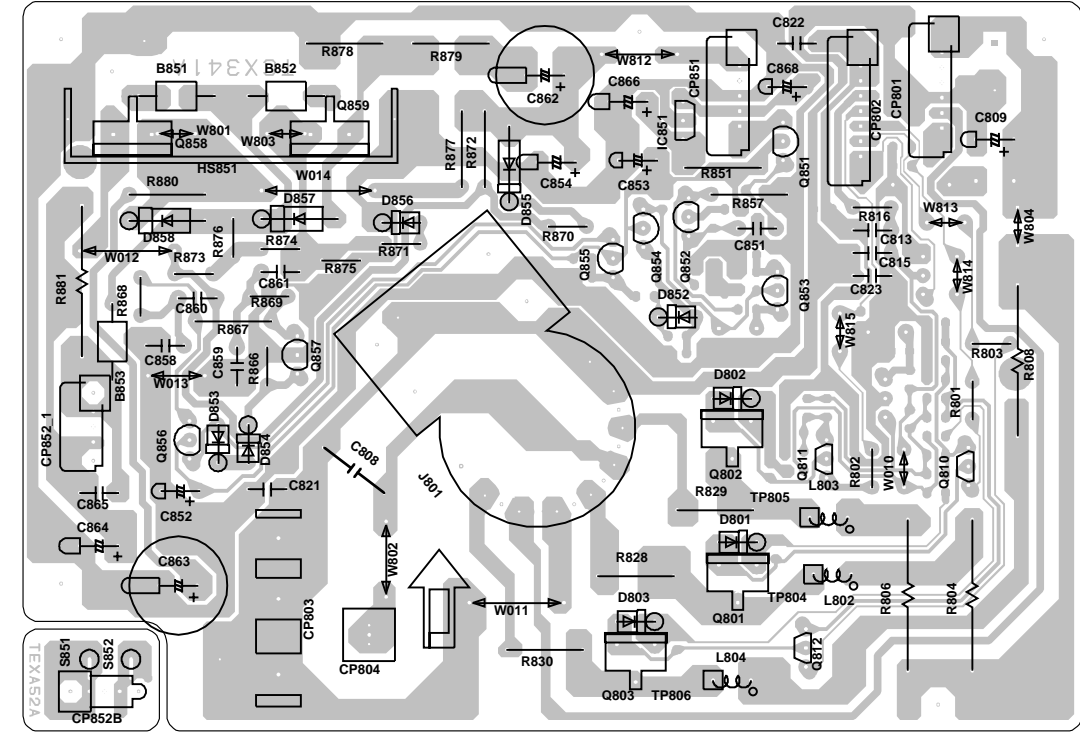

[ COMB FILTER PCB PATTERN (CHIP MOUNTED PARTS) ]

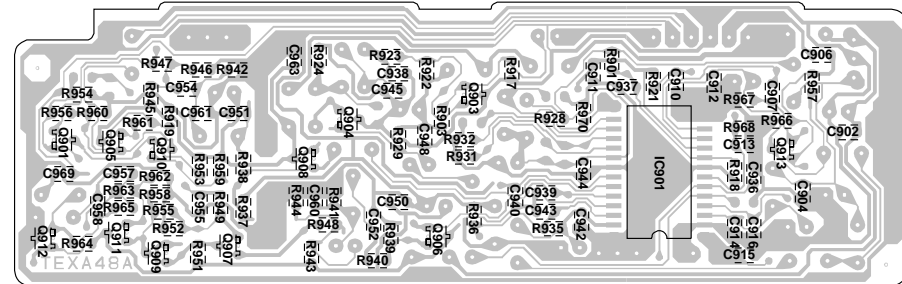

[ CRT/SVM PCB PATTERN (CHIP MOUNTED PARTS) ]

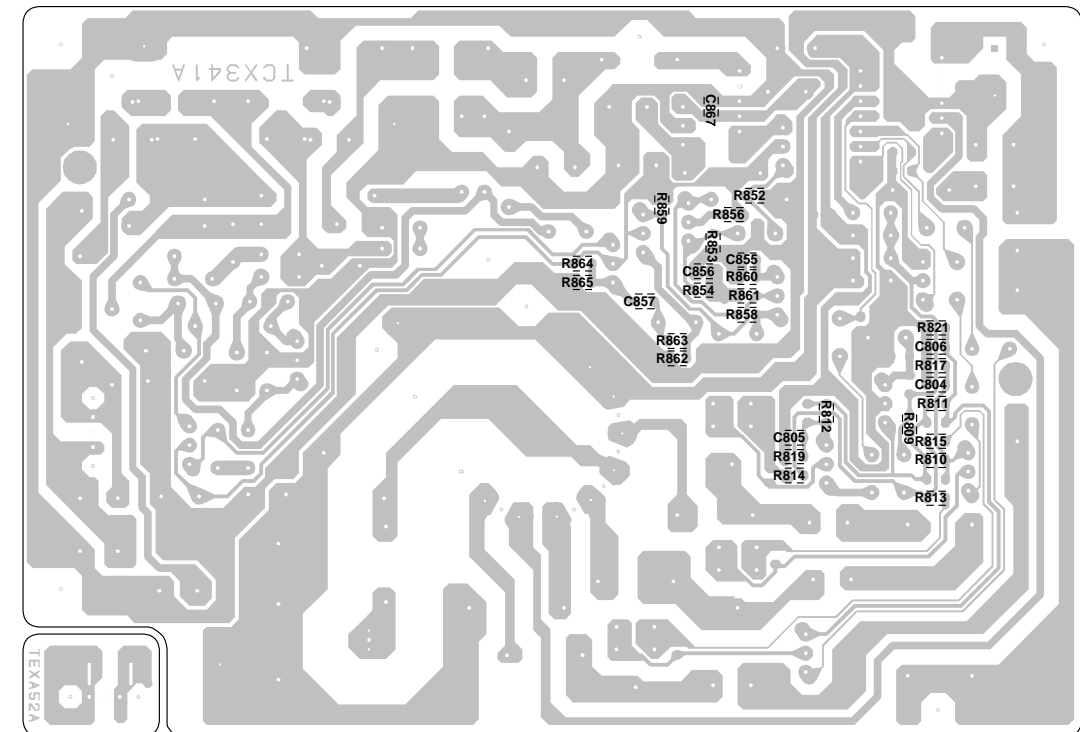

**WAVEFORMS**

**MICON/TUNER**

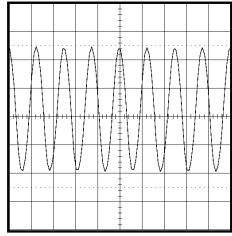

① 1V 0.1 s/div

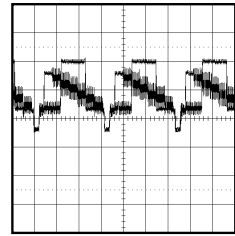

⑥ 1V 20 s/div

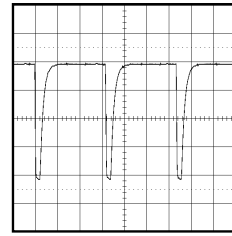

⑪ 0.5V 20 s/div

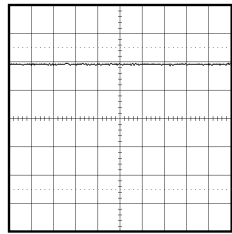

② 1V 1 s/div

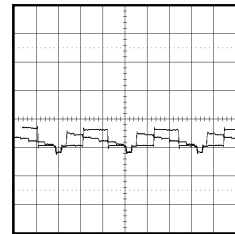

⑦ 1V 20 s/div

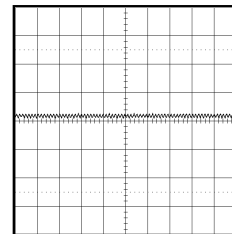

⑫ 1V 2 s/div

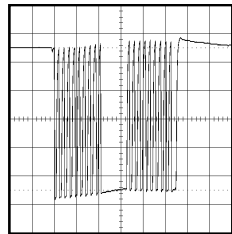

③ 1V 50 s/div

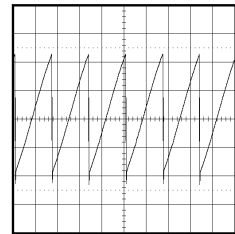

⑧ 0.5V 10ms/div

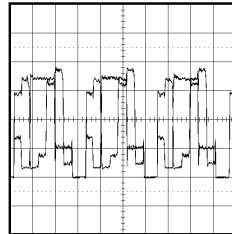

⑬ 1V 20 s/div

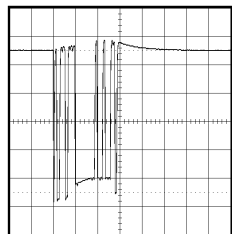

④ 1V 0.1ms/div

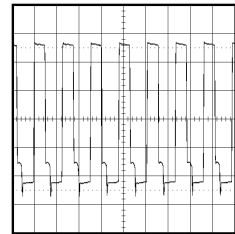

⑨ 1V 50 s/div

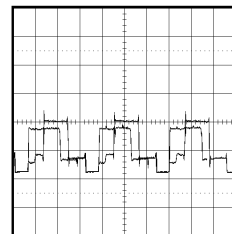

⑭ 2V 20 s/div

**CHROMA/IF**

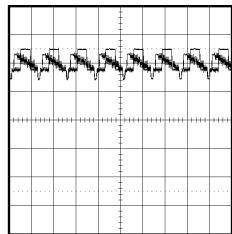

⑤ 1V 50 s/div

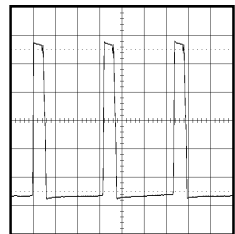

⑩ 2V 20 s/div

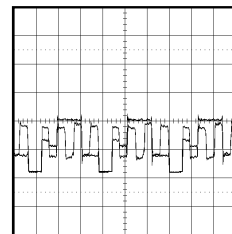

⑮ 2V 20 s/div

**DEFLECTION**

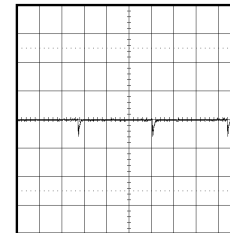

⑯ 2V 5ms/div

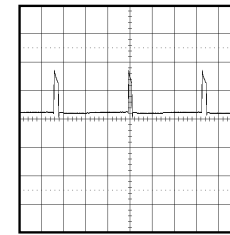

⑰ 20V 5ms/div

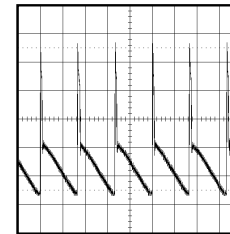

⑱ 10V 10ms/div

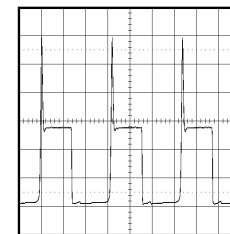

⑲ 20V 20 s/div

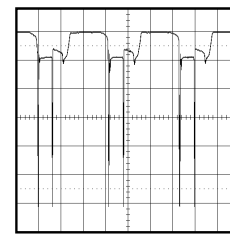

⑳ 2V 20 s/div

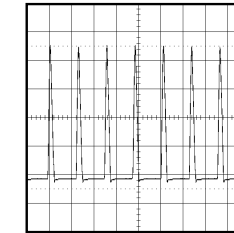

㉑ 200V 50 s/div

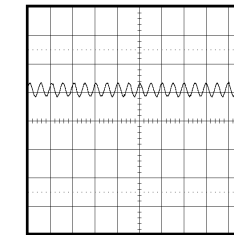

㉒ 2V 5ms/div

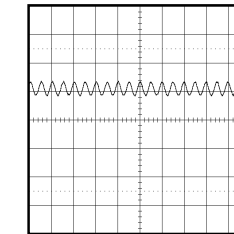

㉓ 2V 5ms/div

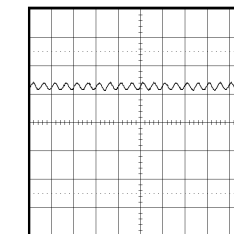

㉔ 2V 5ms/div

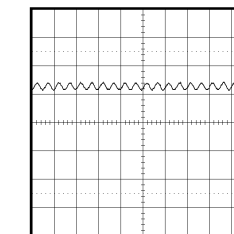

㉕ 2V 5ms/div

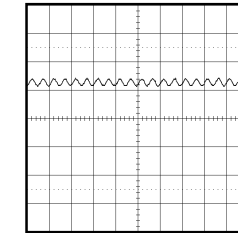

㉖ 5V 2ms/div

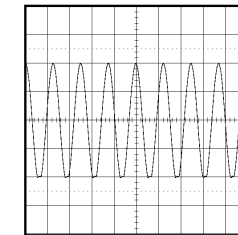

㉗ 5V 2ms/div

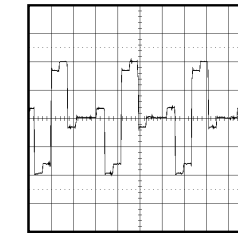

㉘ 200mV 20 s/div

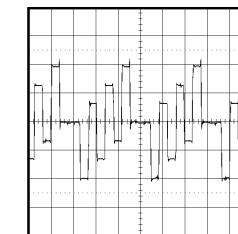

㉙ 200mV 20 s/div

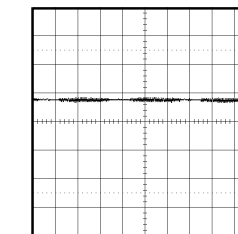

㉚ 2V 20 s/div

**SOUND**

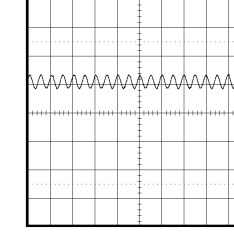

㉒ 2V 5ms/div

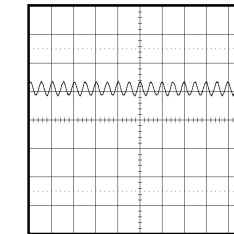

㉓ 2V 5ms/div

**AV**

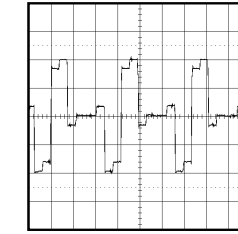

㉘ 200mV 20 s/div

NOTE: The following waveforms were measured at the point of the corresponding balloon number in the schematic diagram.

NOTE: The following waveforms were measured at the point of the corresponding balloon number in the schematic diagram.



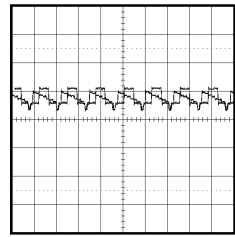

③① 1V 50 s/div

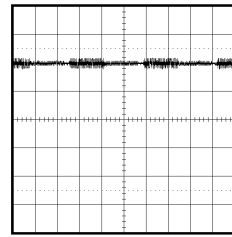

③⑥ 1V 5ms/div

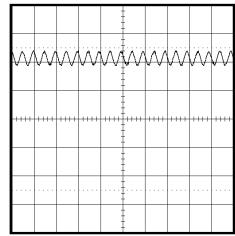

③② 2V 5ms/div

**CRT**

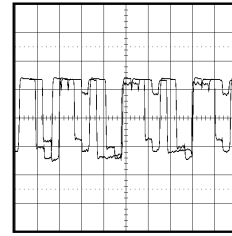

③⑦ 50V 20 s/div

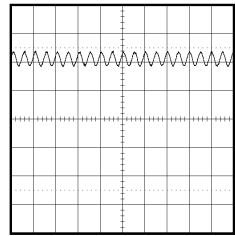

③③ 2V 5ms/div

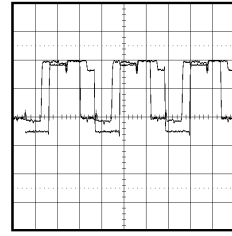

③⑧ 50V 20 s/div

**COMB FILTER**

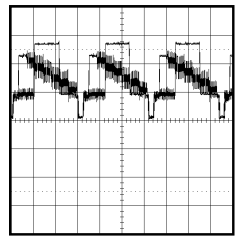

③④ 0.5V 20 s/div

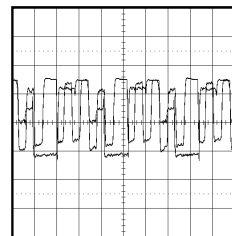

③⑨ 50V 20 s/div

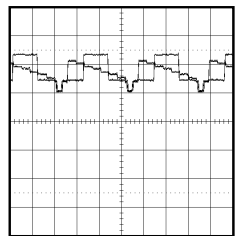

③⑤ 1V 20 s/div

NOTE: The following waveforms were measured at the point of the corresponding balloon number in the schematic diagram.



